

Tapping ZettaRAM™ for Low-Power Memory Systems

Ravi K. Venkatesan, Ahmed S. AL-Zawawi, Eric Rotenberg



Center for Embedded Systems Research (CESR)
Department of Electrical & Computer Engineering
North Carolina State University

ZettaRAM

- New memory from ZettaCore™
 - Genesis in DARPA Moletronics
 - Molecule stores 1 charge
- Long-term
 - 1 molecule = 1 bit
- Near-Term
 - Use molecules in aggregate
 - Replace DRAM capacitor

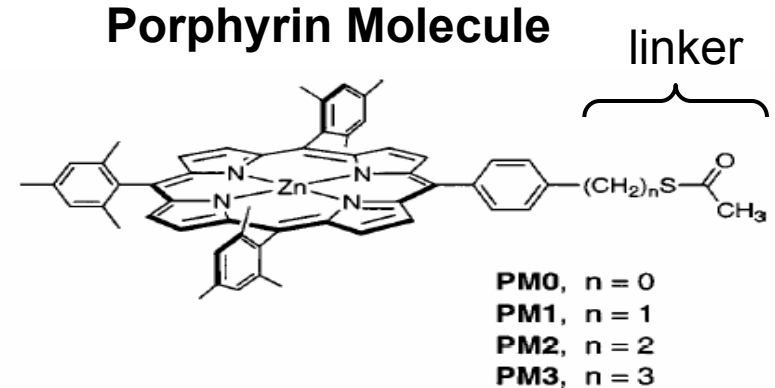

ZettaRAM Molecular Capacitor

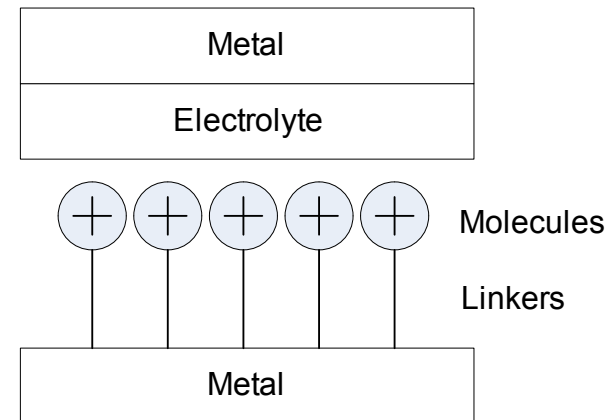

Benefits

➤ Manufacturing

- Self-assembly
- High charge density
- Precise control of molecules' attributes

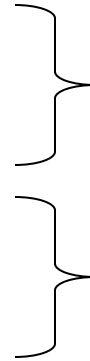

cost-effectively scale
DRAM density

flexibly control density,
performance, energy

➤ Other unusual properties?

➤ Architectural opportunities?

DRAM

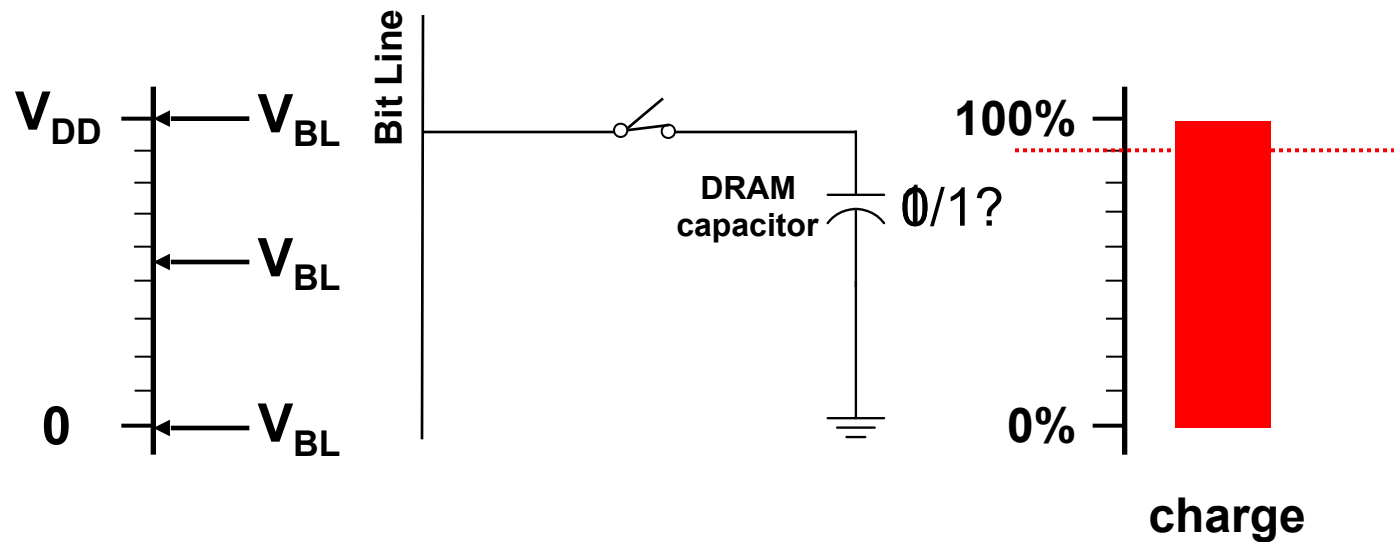

ZettaRAM

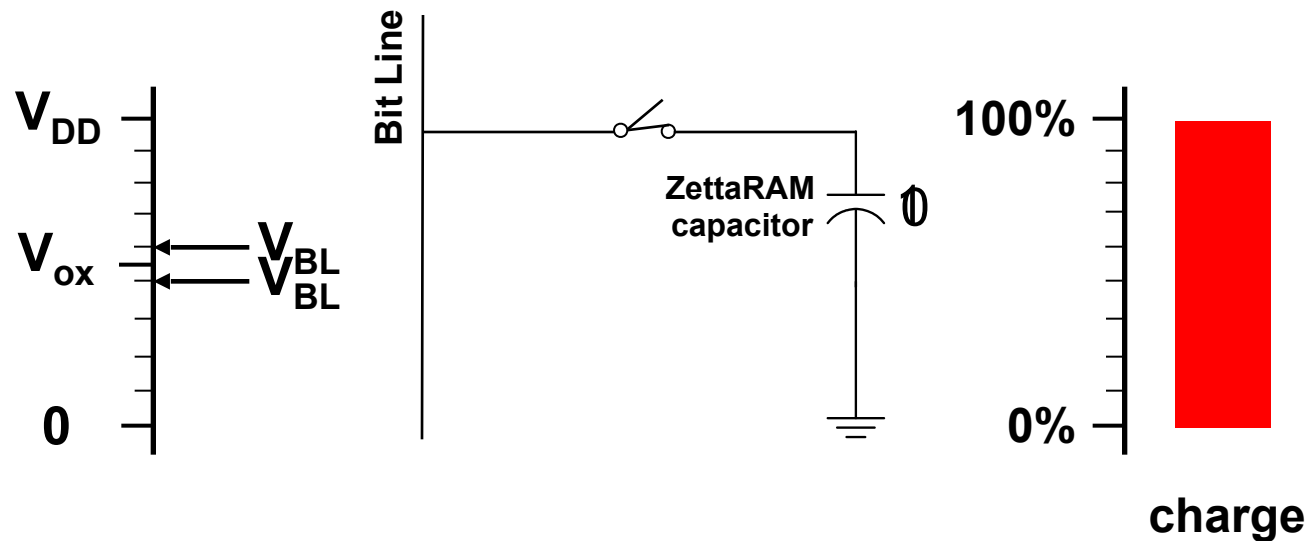

$$E_{bitline} = C_{BL} \cdot V_{BL} \cdot \Delta V_{BL}$$

Very low-power memory

But...

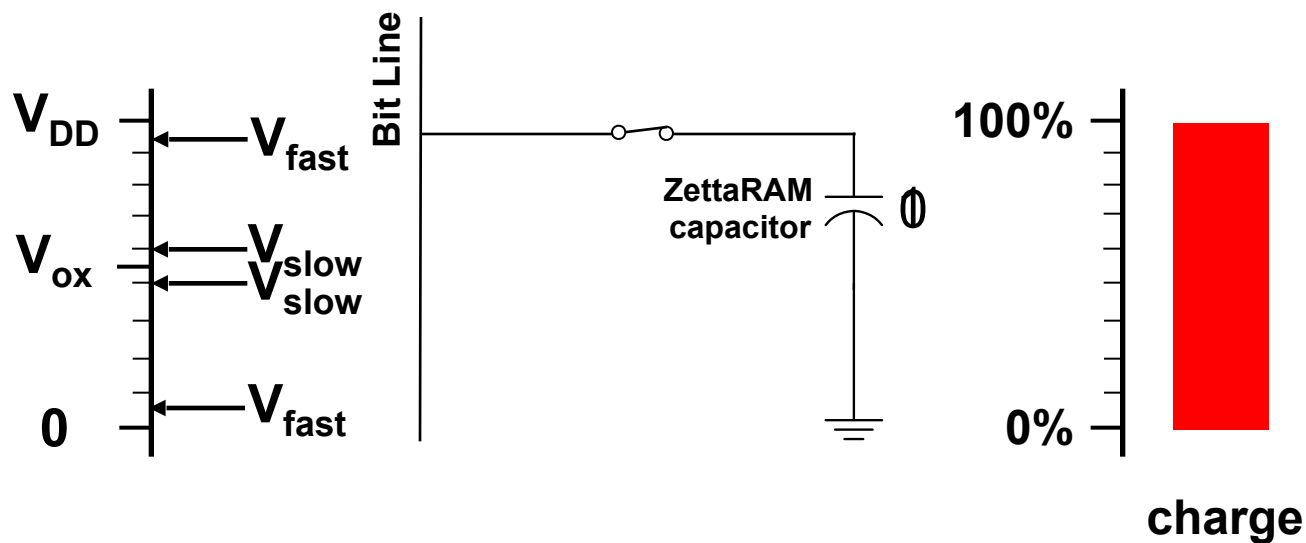

Speed-energy tradeoff

SPICE Results

- SPICE model based on Butler-Volmer equation

$$I \propto e^{\pm k(V_{BL} - V_{ox})}$$

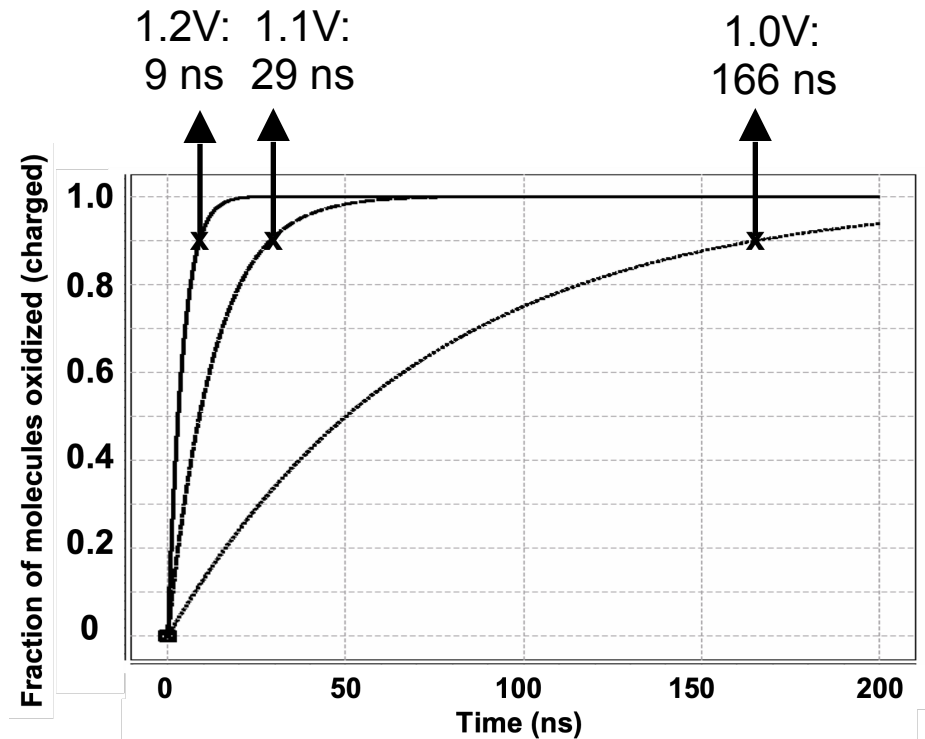
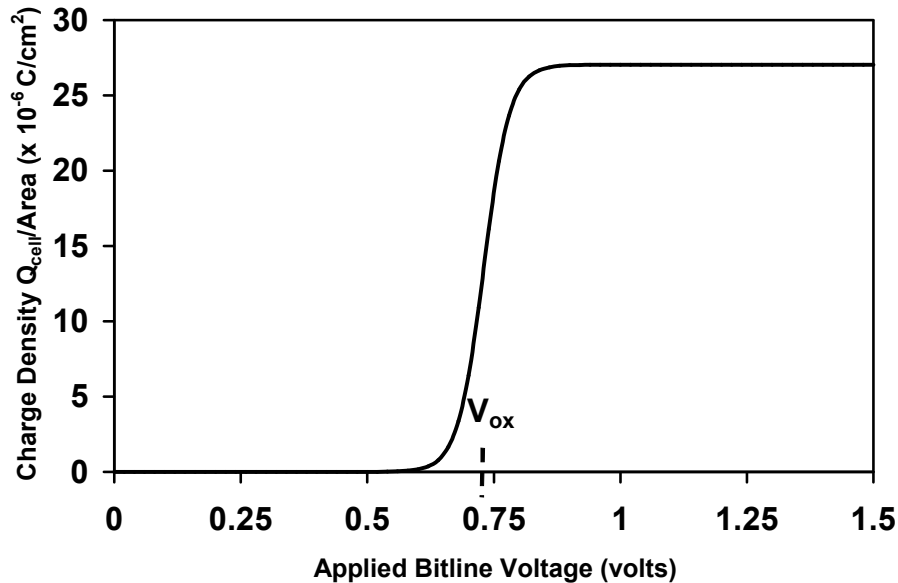

ZettaRAM : Performance-Energy Tradeoff

Bitline energy w.r.t. DRAM

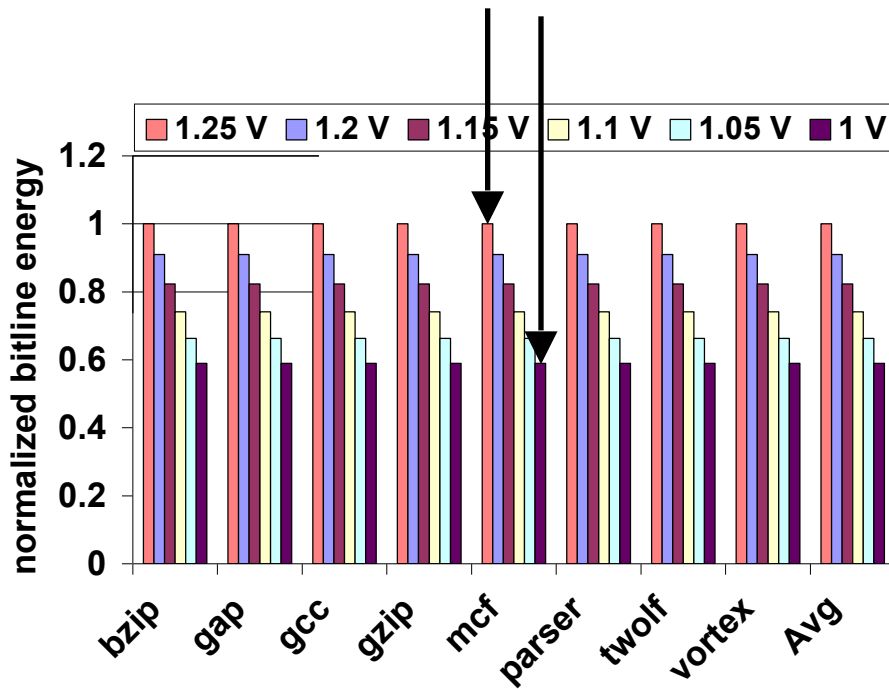

Execution time w.r.t. DRAM

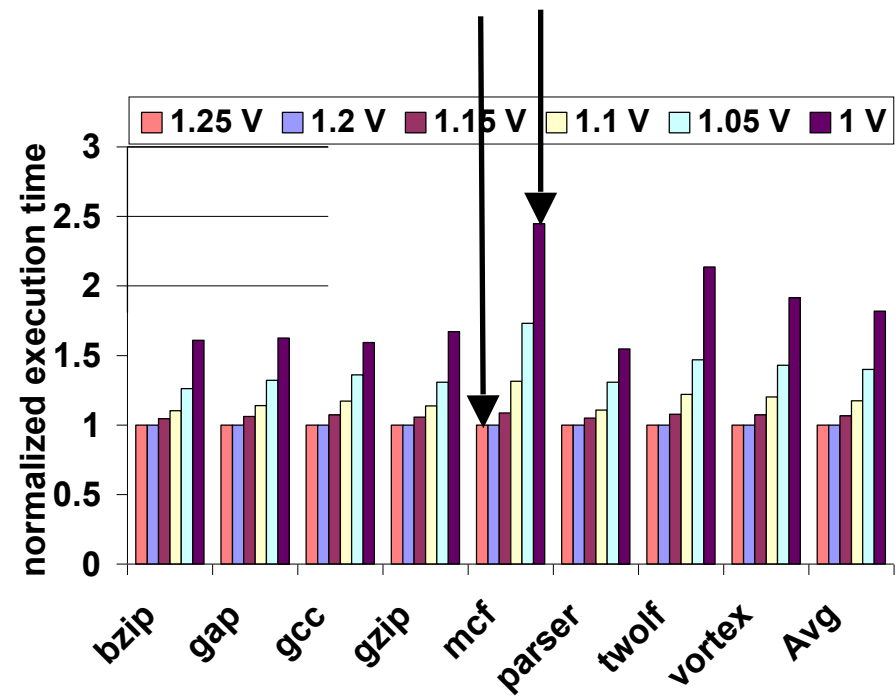

Goal

- ZettaRAM offers novel performance-energy tradeoff
 - DRAM inflexible
- Architectural techniques to manage main memory
 - Tap the energy-savings potential
 - Minimize performance degradation

Source of Bitline Activity

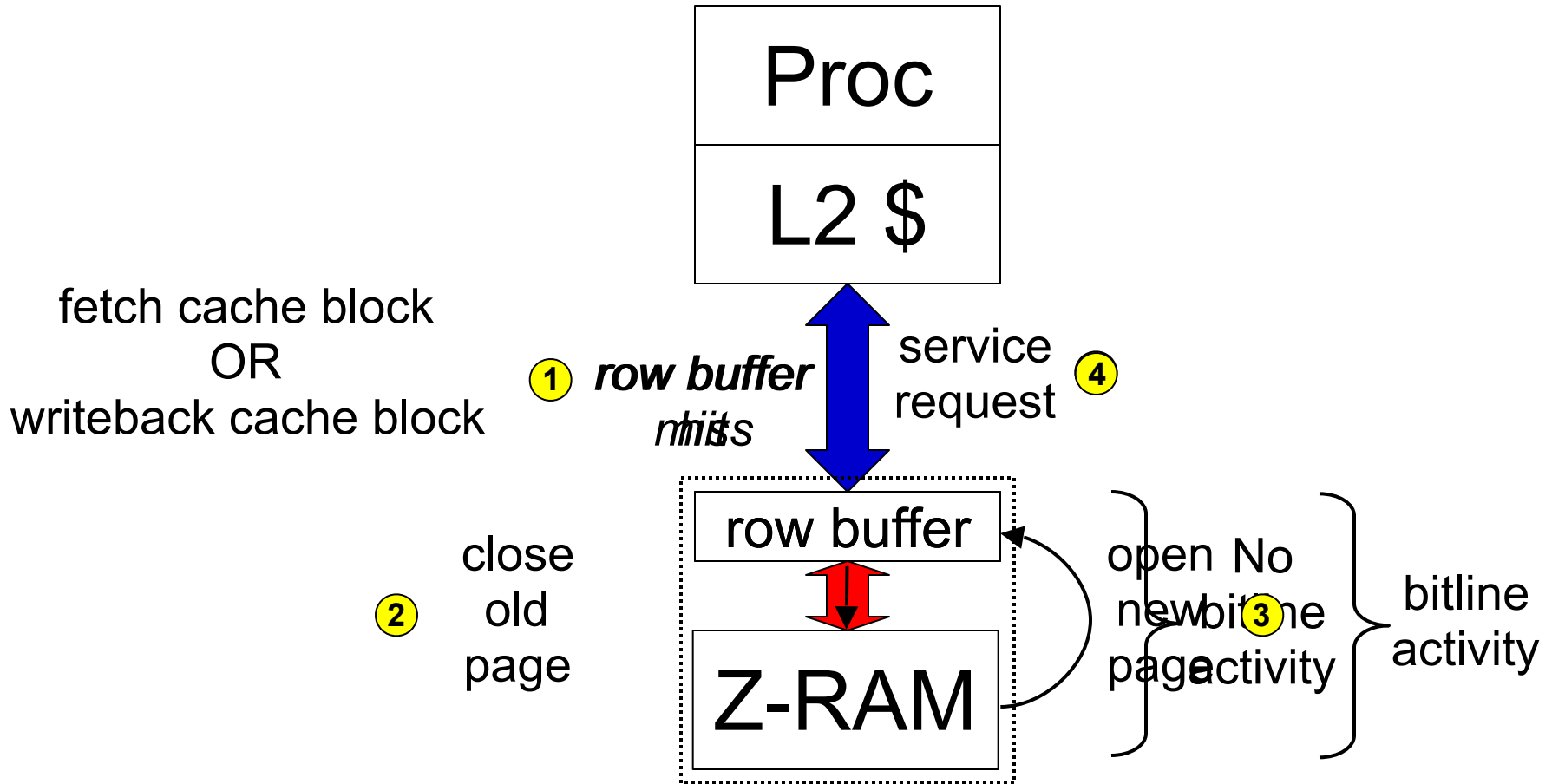

Row Buffer Miss Rates

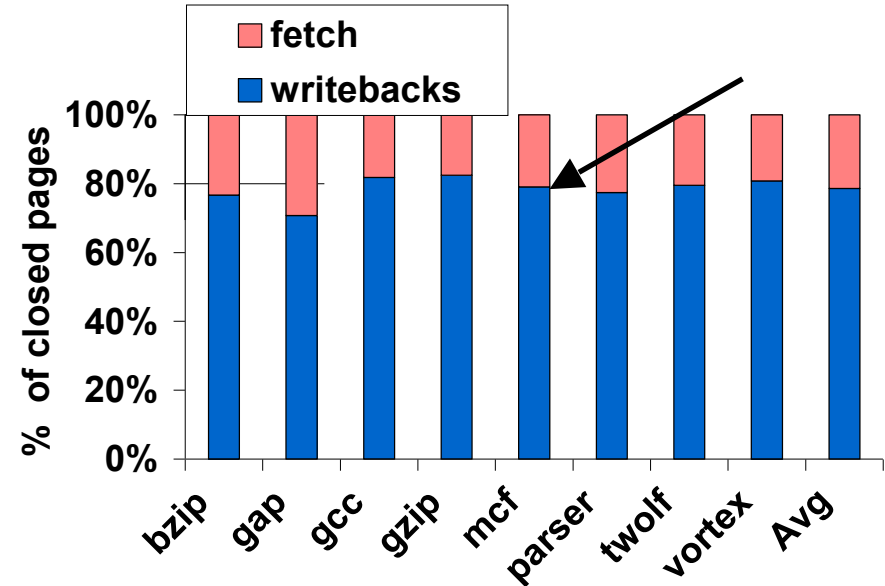
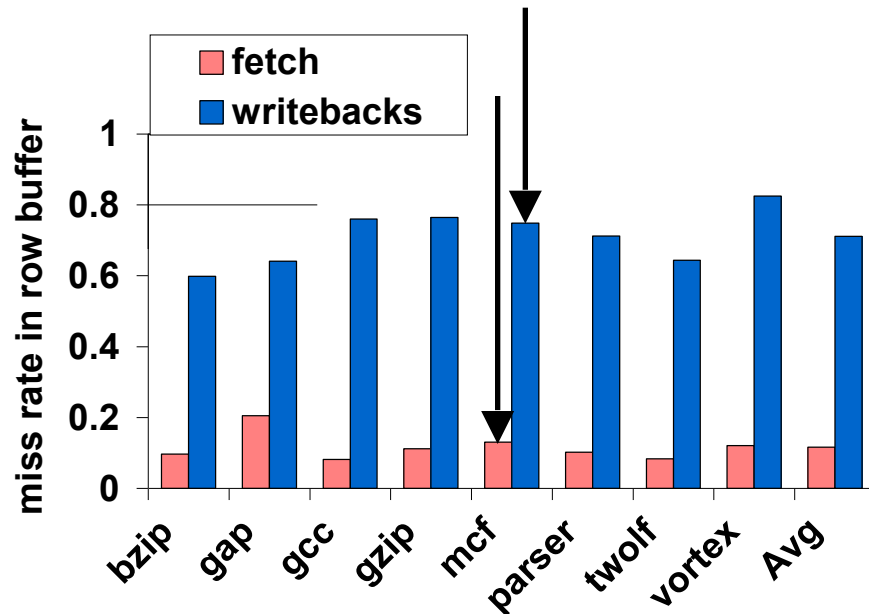

- L2 writebacks account for 80% of bitline activity
 - Most of energy consumption

Ideal Combination of Factors

Target writebacks

- Most of energy savings potential
- Not performance-critical

Hybrid Policy

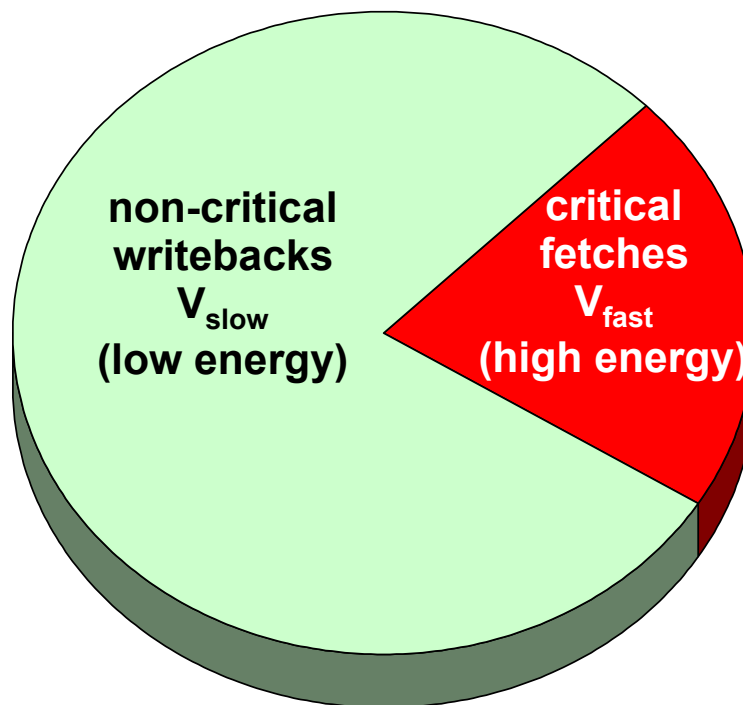

Hybrid Policy

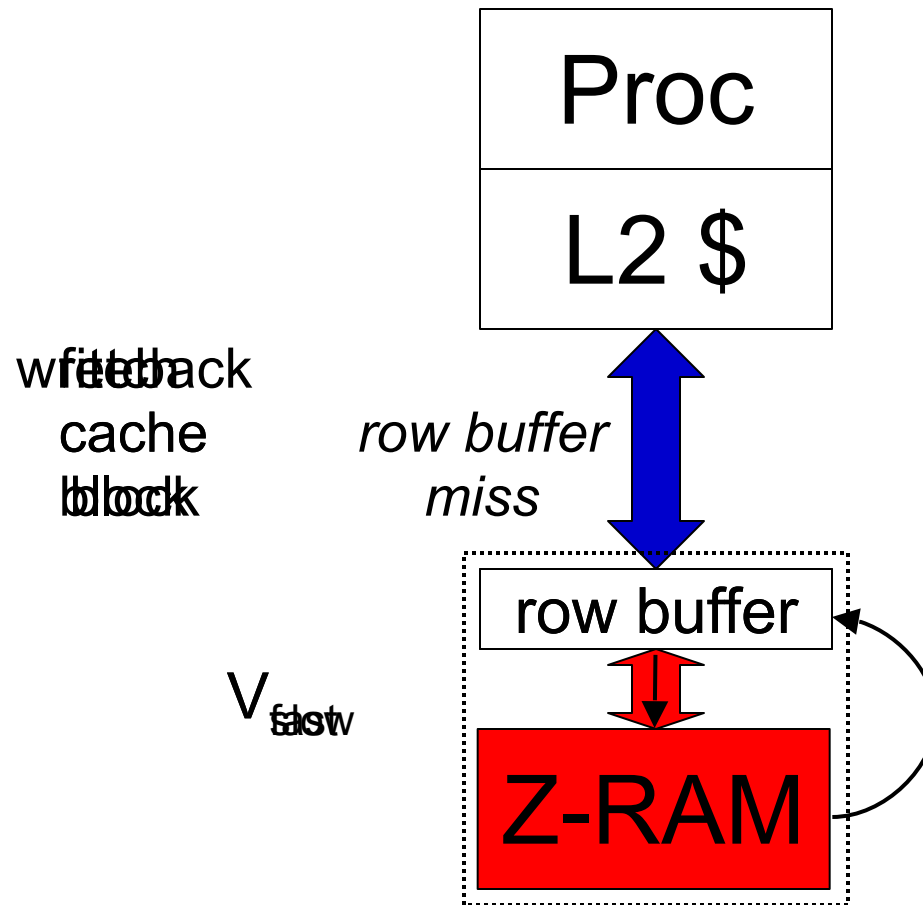

Hybrid Policy

Bitline energy w.r.t. DRAM

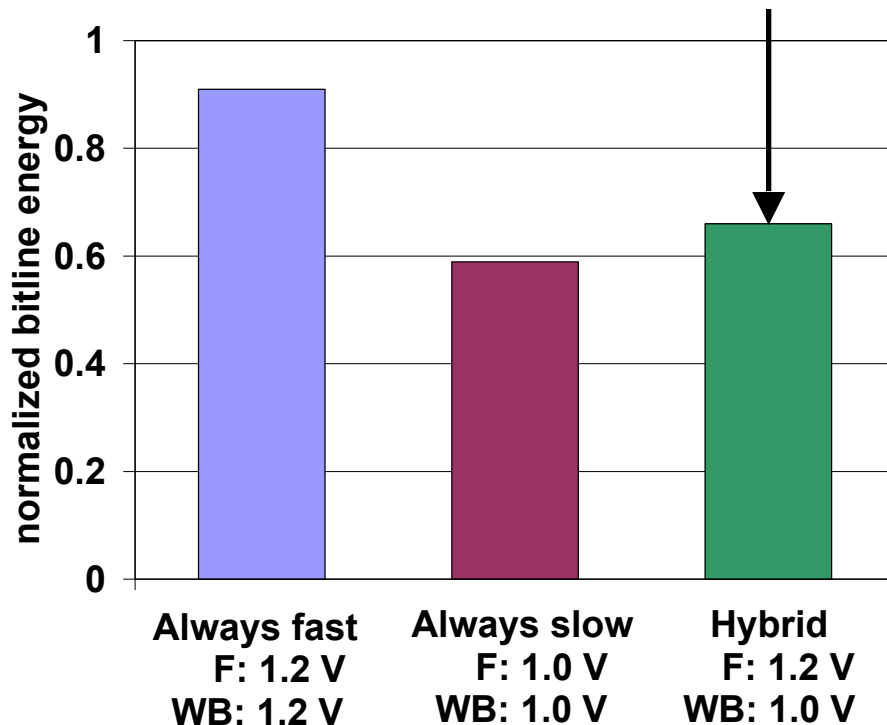

Execution time w.r.t. DRAM

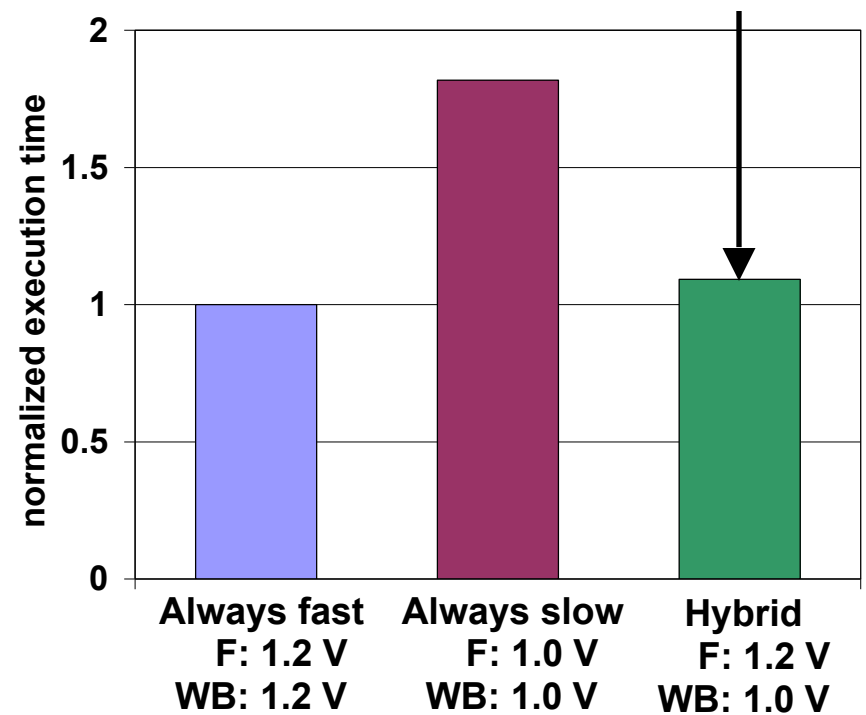

Eliminating Residual Slowdown

- Residual 10% slowdown
 - Delayed writebacks occupy queues in memory controller
 - Eventually stalls processor (indirectly)
- Tolerating delayed writebacks
 - Large buffers with access reordering
 - L2-cache eager writeback [Lee et al., MICRO33, 2000]

Large Buffers with Access Reordering

Bitline energy w.r.t. DRAM

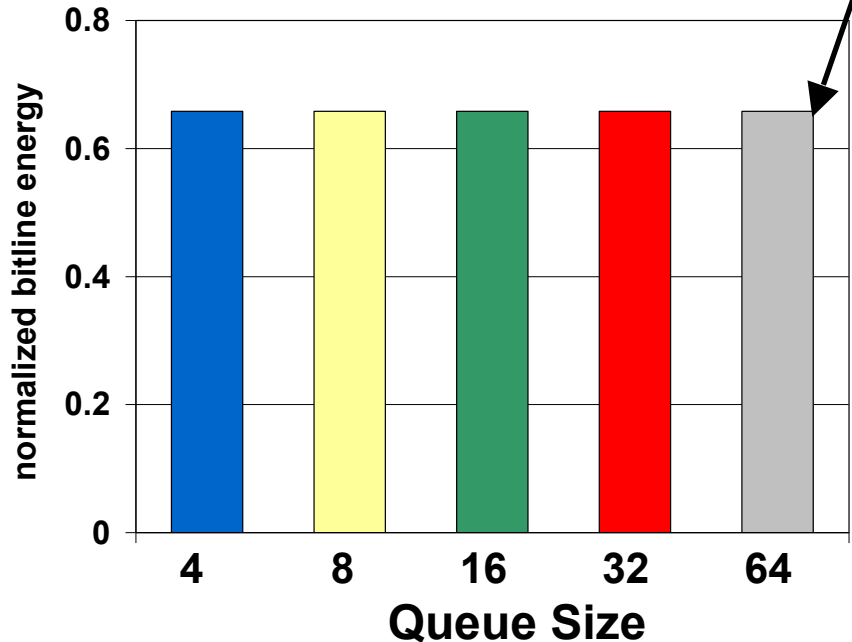

Execution time w.r.t. DRAM

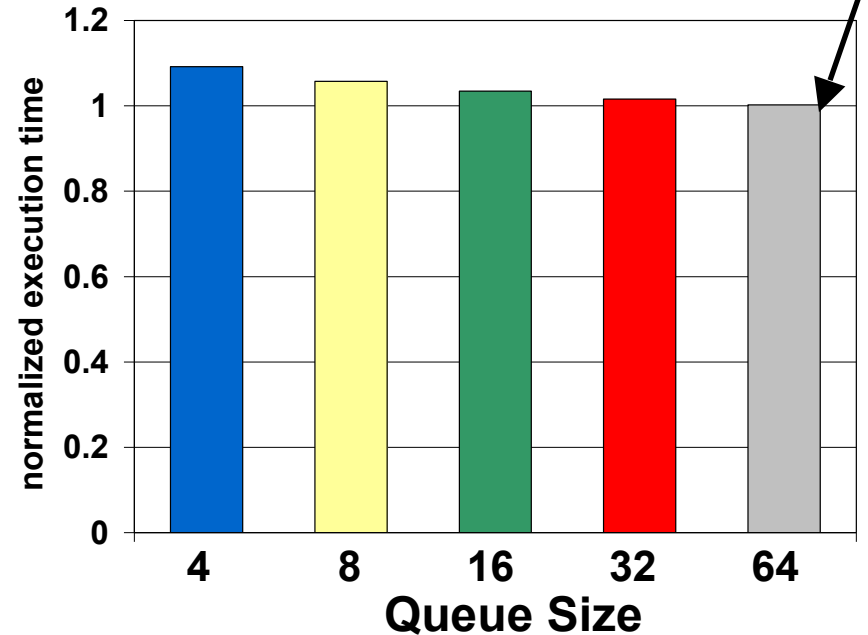

➤ Enlarging queue increases

- Cost: each entry contains cache block
- Complexity: fetches that bypass writebacks must first search queue for read-after-write hazards

L2 Cache Eager Writeback

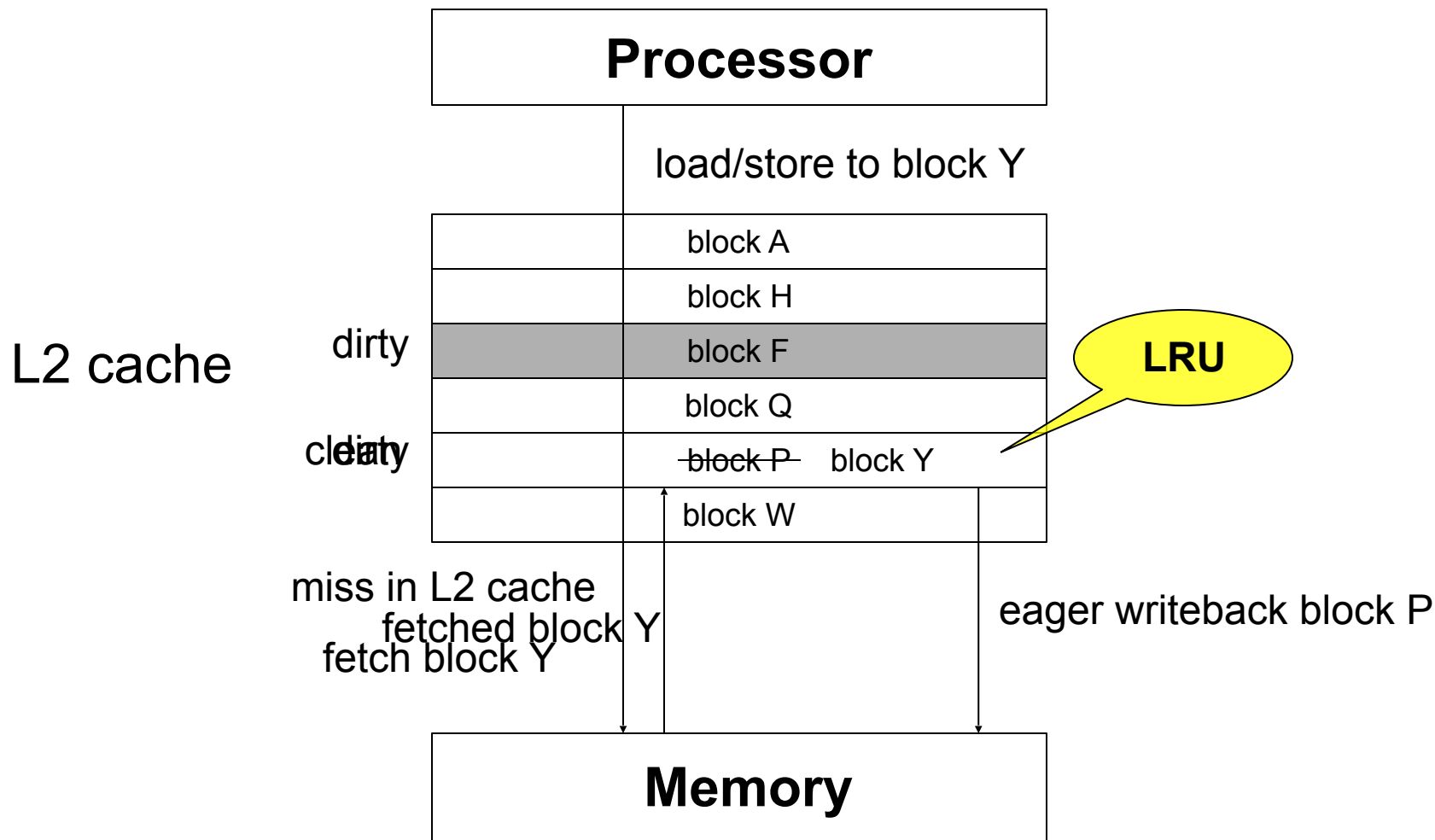

De-clustering L2 writeback requests

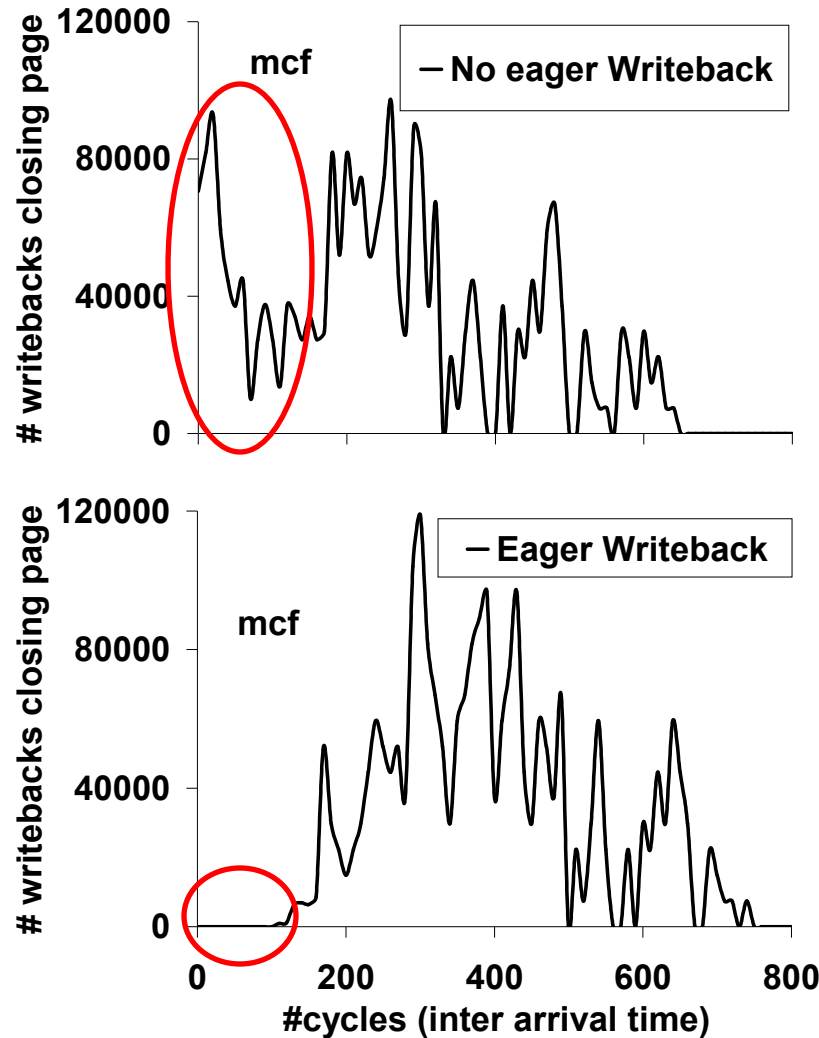

Hybrid policy with
4 queue entries

Hybrid policy with
4 queue entries
in conjunction with
eager writeback

Hybrid Policy + Eager Writeback in L2 cache

Bitline energy w.r.t. DRAM

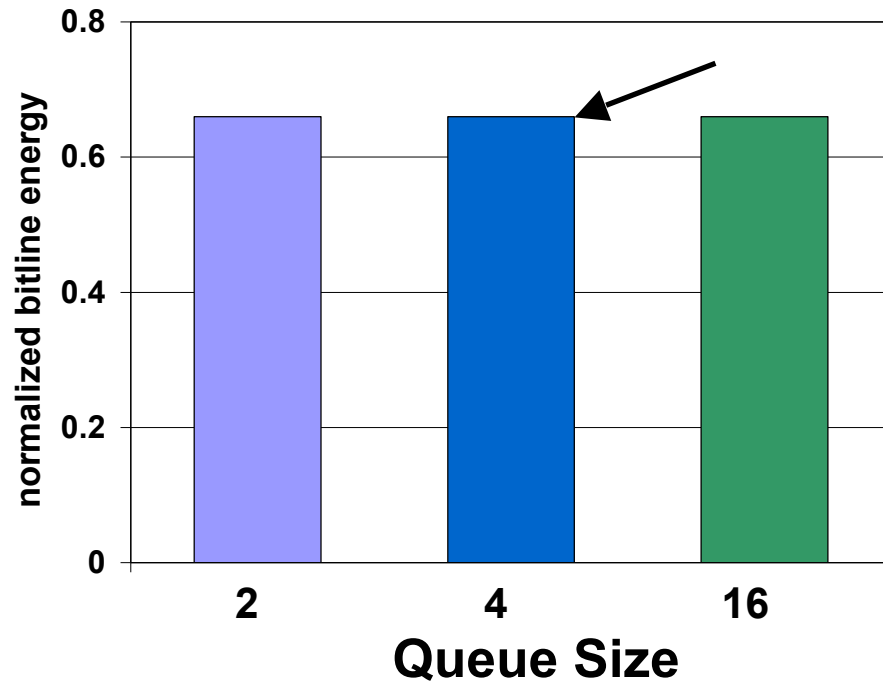

Execution time w.r.t. DRAM

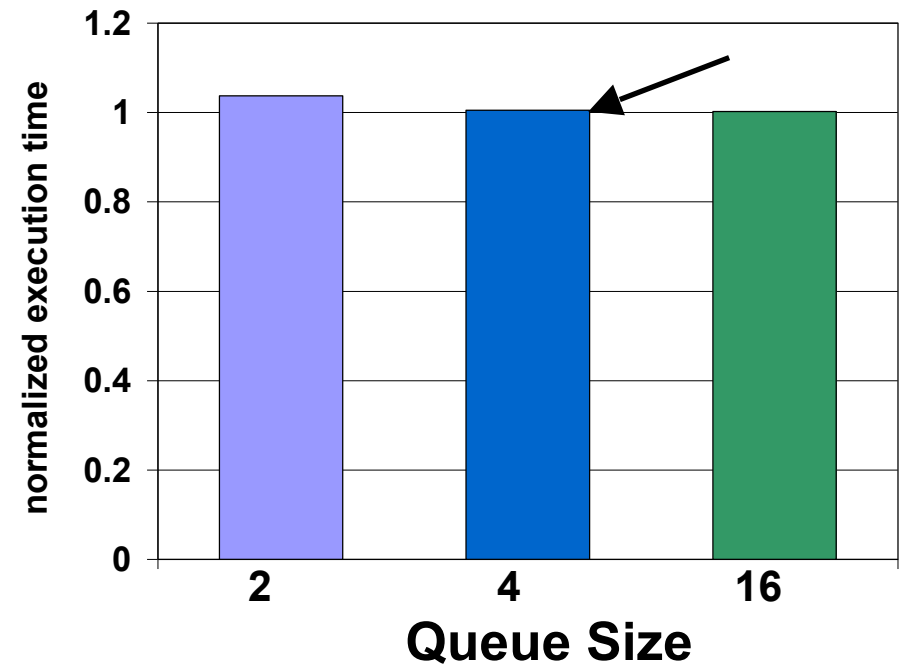

Conclusions

- Molecular capacitor unique
 - Functional with arbitrarily small voltage swings
 - Speed is voltage dependent
- Intelligently managing ZettaRAM
 - Hybrid policy
 - Eager writeback synergistic with ZettaRAM
- Results
 - 34% energy savings (out of 41% with uniformly slow writes)
 - Less than 1% performance degradation

Thank You

Questions !?!

- o The ZettaRAM™ mark is a trademark of ZettaCore Inc
- o The ZettaCore™ mark is a trademark of ZettaCore Inc